

SB60x30-8TD-xH-SC

inches

60 X 30 SOLID SURFACE SHOWER BASE WITH RH OR LH TRENCH DRAIN
IMI SOLIDCAST™

Exterior Dimensions: 59 3/4 W x 30 D

Note: Base dimensions may vary +/- 1/4"

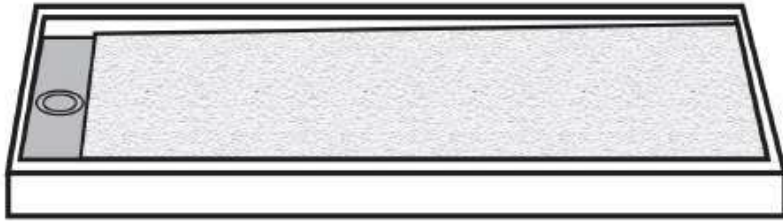

FEATURES

- Single-piece cast engineered stone receptors
- Non-porous through body color material (no gel-coat or other top-coat finishes included)
- Contains a minimum of 60% natural stone material
- Contains premium grade solid surface resin, NPG-isophthalic (ISO), UV inhibited acrylic based polyester resin
- Meets Slip-Resistance Requirements as described in ANSI Code 2514.03.A
- Features a water-tight tile flange anywhere where the wall meets the base that is not thicker than 3/16"
- Pre-leveled, rests on subfloor

STANDARDS AND RATINGS

- Typical CSI Code: 22 42 23 (Div 22)
- ANSI
- ASTM (Fire Rating)
- MAS Certified Green
- Slip-resistance: SCoF = 0.6+, wet; DCoF = 0.42+
- Breaking strength: 250 lbs. minimum

*See terms and conditions for details.

Material to be stacked on pallets.

COLOR & TRIM OPTIONS

Standard Color	Code
White	SW

Additional custom colors available.

IMI
INTERNATIONAL MARBLE INDUSTRIES
Solid Surface Solutions



ABG HOSPITALITY

imitoday.com

SB60x30-8TD-xH-SC

60 X 30 SOLID SURFACE SHOWER BASE WITH RH OR LH TRENCH DRAIN

IMI SOLIDCAST™

Note: Base dimensions may vary +/- 1/4"

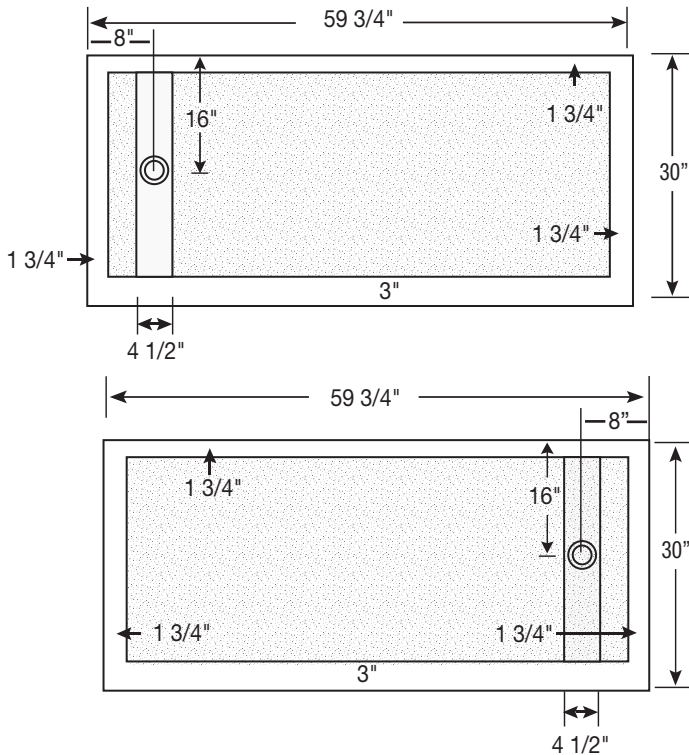

Side View of Curb

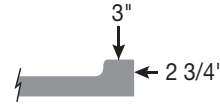

Drain Cover

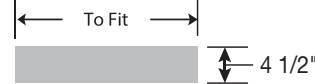

Drain Details: (U.S.)

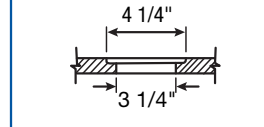

Flange Details: (U.S.)

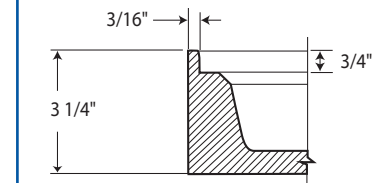



FEATURES Dimensional Tolerance $\pm 1/4"$. Dimensions needed for site preparation should be measured from the unit. American Bath Group assumes no responsibility for preparatory work.

Type and Model #	Material	Shower Base	Pieces
Shower Base #SB60x30-8TD-xH-SC	Cast Solid Surface	Anti-Slip/Textured Finish	1

DIMENSIONS

Specifications	inches
Shower Base Depth:	30
Shower Base Width:	59 3/4
Curb Height:	2 3/4
Curb Width:	3

SUGGESTED DRAINS

Image	Description
	Solvent Weld type fitting similar to Oatey Part No. 42097
	Compression type "No-Caulk" fitting similar to Oatey Part No. 42099